



## 3/2-way Solenoid Valve, direct-acting, NC or NO

- Electrical connection cable plug, Form A
- With or without manual override as standard
- Threaded port and sub-base versions
- Impulse version optional

Type 6014 can be combined with...



**Type 2508**  
Cable Plug



**Type 1078**  
Timer unit



**Type 6014**  
Multiple manifold  
(e.g. 6-fold)



**Type 2511**  
ASI cable plug

This direct-acting 3/2-way solenoid valve may be mounted singly or in flange version on a manifold. FKM high quality seal material can be used for a lot of different mediums. The valve is also suitable for technical vacuum.

### Circuit function C

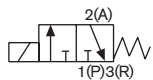

3/2-way valve NC,  
outlet 2 relieved

### Circuit function D

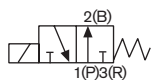

3/2-way valve NO, outlet 2  
normally pressurized

### Circuit function T

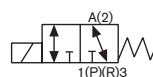

3/2-way,  
universal valve

### Technical data

<b>Body material</b>	Brass or stainless steel, polyamide (sub-base)
<b>Seal material</b>	FKM (EPDM on request)
<b>Medium</b>	Neutral gases and fluids (e.g. compressed air, town gas, natural gas, water, hydraulic oil, petrol). Suitable for technical vacuum
<b>Medium temperature</b> Polyamide coil (FKM seal)	-10° to +100°C (PA coil) to 120°C Epoxy coil
<b>Ambient temperature</b>	-10 to +55°C
<b>Viscosity</b>	Max. 21 mm <sup>2</sup> /s
<b>Port connection</b>	G 1/8, G 1/4, sub-base
<b>Operating voltage</b>	24 V DC, 24 V/50 Hz, 230 V/50 Hz (other voltages on request)
<b>Voltage tolerance</b>	±10%
<b>Duty cycle / single valve</b> Assembly	100% continuous rating Intermittent operation 60% (30 min) or with 5 W coil (on request)
<b>Electrical connection</b> According to	DIN EN 175301-803 Form A for Cable Plug, Type 2508 (see Ordering chart for accessories)
<b>Installation</b>	As required, preferably with actuator upright
<b>Protection class</b>	IP65 with Cable Plug
<b>Coil insulation class</b>	Polyamide class B (Epoxy class H on request)
<b>Coil material</b>	Polyamide (Epoxy on request)
<b>Orifice</b>	DN 1.5- 2.5

## Technical data

### Power consumption

Orifice [mm] [mm]	Power consumption			DC hot / cold coil [W]
	Inrush AC [VA]	Hold AC (hot coil) [VA]	[W]	
1.5-2.5	24	17	8	8 / 9

### Response times

Orifice [mm]	Response times AC and DC	
	Opening [ms]	Closing [ms]
1.5	10-15	15-20
2.0	10-15	15-20
2.5	15-20	10-22

**Response times [ms]:**  
Measured at valve outlet at 6 bar and +20°C.  
Opening: Pressure build-up 0 - 90%, to

Closing: Pressure relief 100 to 10%

### Utilisation in another circuit function

Valves with circuit functions (WW) C, D and T are fitted with different springs. If used in some other circuit function, the permissible operating pressure may change (see table below).

Valve Version Basic version		Max. operating pressure [bar] for valve application in circuit function				
DN	Circuit function	A	B	C	D	T
1.5	C	16	22	16	2	2
	D	2	2.5	2	16	2
	T	10	16	10	6	6
2.0	C	10	14	10	1	1
	D	1	1.5	1	10	1
	T	6	10	6	4	4
2.5	C	6	9	6	0.7	0.7
	D	0.7	1	0.7	6	0.7
	T	3.5	6	3.5	2.5	2.5

### Connections

For the positions marked with \*, \*\* or \*\*\* in the drawing, the connections are marked with the letters shown in the table above, depending on the circuit function. Unused connections in circuit functions A or B will be closed off with a blanking plug or cap nut.

Circuit function	Connection Type		
	*	**	***
A	P	blank off	A
B	blank off	B	P
C	P	R	A
D	R	P	B
T	P	R	A

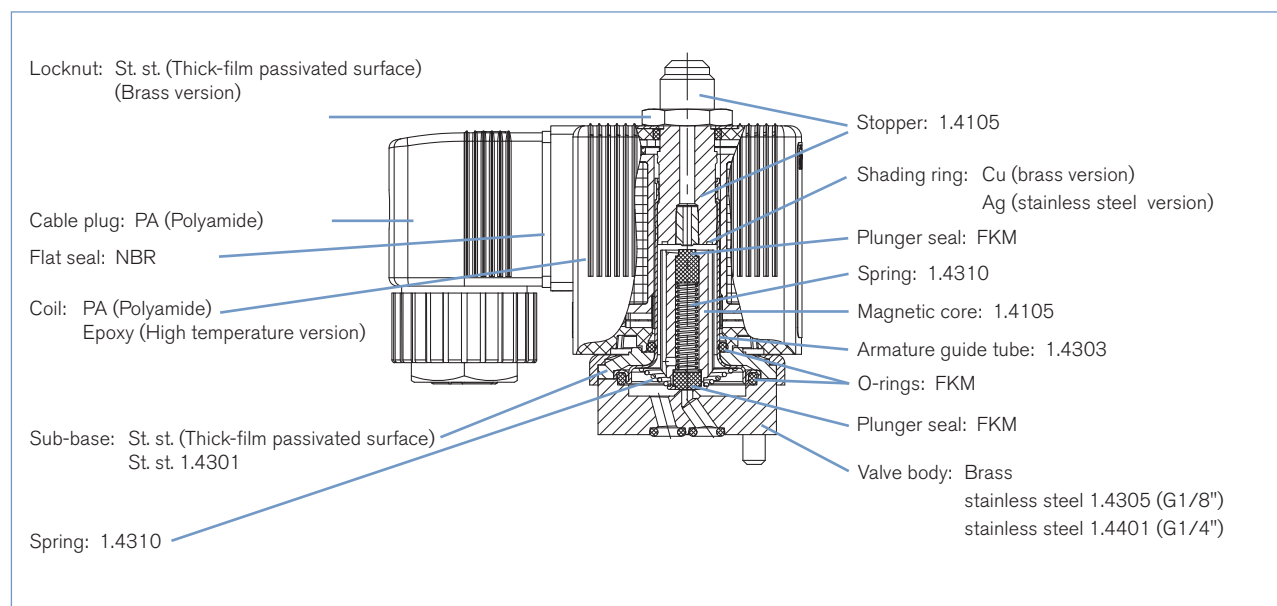

\* see drawing on page 7

## Materials

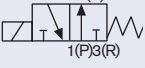
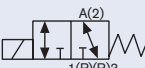
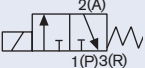
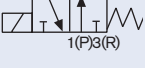
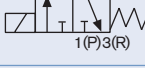

## Ordering chart for valves (other versions on request)

## Valves with threaded port

Circuit function	Orifice [mm]	Port connection	Kv value water [m <sup>3</sup> /h] <sup>1)</sup>	Pressure range [bar] <sup>2)</sup>	Effective coil power [W]	Item no. per voltage / frequency		
						024/DC	024/50	230/50
<b>Brass body</b>								
<b>without manual override</b>								
<b>C</b> 3/2-way valve NC 	1.5	G 1/8	0.07	0 - 16	8	125 329	125 331	125 332
	2.0	G 1/8	0.11	0 - 10	8	125 333	125 334	125 336
		G 1/4	0.11	0 - 10	8	125 348	126 138	126 140
	2.5	<b>G [mm]</b> 1/8	0.16	0 - 6	8	125 341	125 340	125 342
		G 1/4	0.16	0 - 6	8	126 142	126 143	126 145
<b>D</b> 3/2 way valve, NO 	1.5	G 1/8	0.07	0 - 16	8	126 195	126 196	125 355
	2.0	G 1/8	0.11	0 - 10	8	125 357	125 358	125 360
		G 1/4	0.11	0 - 10	8	126 198	126 199	126 201
	2.5	G 1/8	0.16	0 - 6	8	125 363	126 202	126 204
G 1/4		0.16	0 - 6	8	126 205	126 206	126 208	
<b>T</b> 3/2-way Universal valve 	1.5	G 1/8	0.07	0 - 7	8	126 150	126 151	126 153
<b>with manual override</b>								
<b>C</b> 3/2-way valve NC 	2.0	G 1/8	0.11	0 - 10	8	125 337	125 338	125 339
		G 1/4	0.11	0 - 10	8	125 349	126 147	126 149
<b>D</b> 3/2 way valve, NO 	2.0	G 1/8	0.11	0 - 10	8	126 209	125 361	126 211
		G 1/4	0.11	0 - 10	8	126 212	126 213	126 215
<b>Stainless steel body</b>								
<b>C</b> 3/2-way valve NC 	1.5	G 1/8	0.07	0 - 16	8	126 216	126 217	126 219
	2.0	G 1/8	0.11	0 - 10	8	126 220	126 221	126 223
		G 1/4	0.11	0 - 10	8	126 224	126 225	126 227
<b>T</b> 3/2-way, universal valve 	1.5	G 1/8	0.07	0 - 7	8	126 228	126 229	126 231

<sup>1)</sup> Measured at +20 °C, 1 bar<sup>2)</sup> pressure difference<sup>2)</sup> Measured as overpressure to the atmospheric pressure

**Please note** that the cable plug has to be ordered separately, see accessories on page 6 and separate datasheet for Type 2508.

## Ordering chart for valves (other versions on request)

## Valves with sub-base body without cable plug

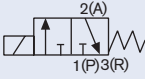
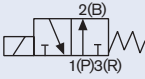
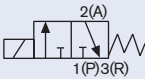
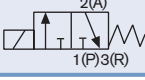
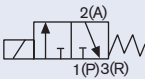
Circuit function	Orifice [mm]	Kv value water [m <sup>3</sup> /h] <sup>1)</sup>	Pressure range [bar] <sup>2)</sup>	Effective coil power [W]	Item no. per voltage / frequency		
					024/DC	024/50	230/50
<b>Brass body</b>							
<b>without manual override</b>							
<b>C</b> 3/2-way valve NC 	1.5	0.07	0 - 16	8	126 154	126 155	125 366
	2.0	0.11	0 - 10	8	125 367	125 368	125 370
<b>D</b> 3/2 way valve, NO 	2.0	0.11	0 - 10	8	126 161	126 162	125 383
<b>with manual override</b>							
<b>C</b> 3/2-way valve NC 	1.5	0.07	0 - 10	5	126 403	126 404	126 406
	1.5	0.07	0 - 16	8	126 157	126 158	126 160
	2.0	0.11	0 - 6	5	126 407	126 408	126 410
	2.0	0.11	0 - 10	8	125 371	125 372	125 374
<b>Polyamide body material</b>							
<b>without manual override</b>							
<b>C</b> 3/2-way valve NC 	1.5	0.07	0 - 10	5	126 390	126 391	126 393
<b>with manual override</b>							
<b>C</b> 3/2-way valve NC 	1.5	0.07	0 - 10	5	126 396	126 397	126 399

<sup>1)</sup> Measured at +20 °C, 1 bar <sup>2)</sup> pressure difference<sup>2)</sup> Measured as overpressure to the atmospheric pressure**Please note** that the cable plug has to be ordered separately, see accessories on page 6 and separate datasheet for Type 2508.

## Ordering chart for valves, impulse version (other versions on request)

All valves with AC10-coil (32 mm), impulse Version, seal material FKM, thermic insulation class H (epoxy coil), medium temperature -10° up to +120°C, without manual override and Cable Plug

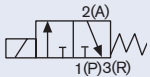
Circuit function	Port connection	Orifice [mm]	Kv value water [m <sup>3</sup> /h] <sup>1)</sup>	Pressure range [bar] <sup>2)</sup>	Power consumption DC (hot/cold coil) [W]	Item no. per voltage/frequency [V/Hz]		
						012/DC	024/DC	
<b>C</b> 3/2-way valve, output 2 exhausted 	<b>Brass body</b>							
	Threaded port	G 1/8	1.5	0.07	0-16	7	209 280	209 284
			2.0	0.11	0-10	7	209 281	209 285
	Sub-base	sub-base	1.5	0.07	0-16	7	209 278	209 282
2.0			0.11	0-10	7	209 279	209 283	

<sup>1)</sup> Measured at +20 °C, 1 bar<sup>2)</sup> pressure difference

<sup>2)</sup> Measured as overpressure to the atmospheric pressure

**Please note** that the cable plug has to be ordered separately, see accessories on page 6 and separate datasheet for Type 2508.

### Activation of the impulse version with inverse polarity operation

The polarity is labelled on the valve	Specifications	Terminal connections
- switch ON +	valve (P-seat) will be opened	(+) on terminal 2 and (-) on terminal 1 (see below)
+ switch OFF -	valve (P-seat) will be closes	(+) on terminal 1 and (-) on terminal 2 (see below)

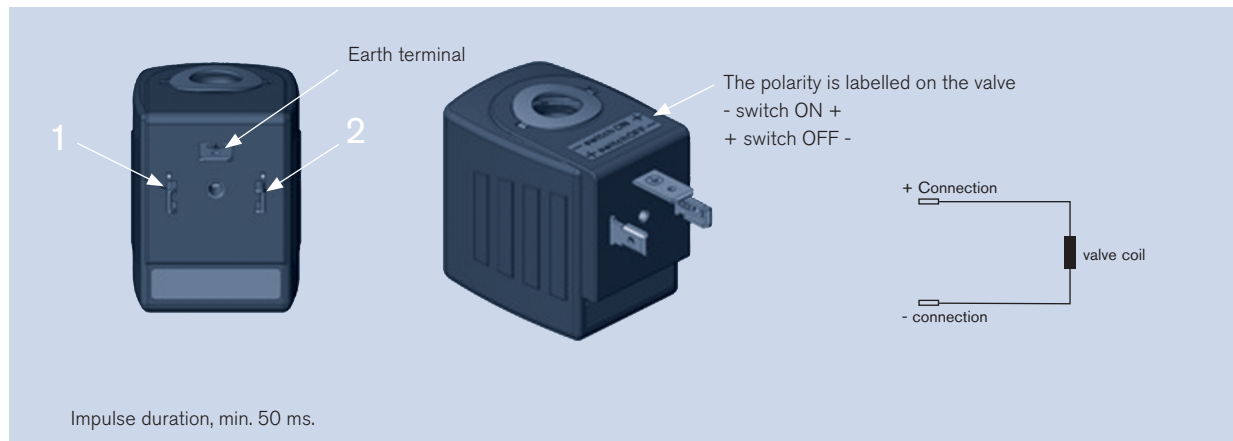

**Note:** Only cable plug without circuitry should be used together with impulse version!

### **i** Further versions on request



**Materials**  
Epoxy coil according to Form A  
Seal material EPDM



**Approvals**  
ATEX, UL, CSA



**Voltage**  
Non-standard voltages



**Additional**  
Orifice: 1.2mm, 3.0mm



**Port connection**  
With banjo nut

## Ordering chart for accessory

### Cable plug Type 2508 according to DIN EN 175301-803 Form A

	Circuitry	Voltage/ Frequency	Item no.
	None (standard)	0 - 250 V AC/DC	008 376
	with LED	12 - 24 V AC/DC	008 360
	with LED and varistor	12 - 24 V AC/DC	008 367
	with LED and varistor	200- 240V	008 369
	with inverter <sup>1)</sup>	24V DC	on request
	further versions see datasheet Type 2508		

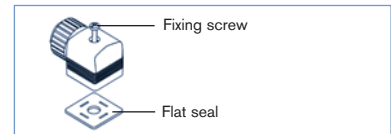

The delivery of a cable plug includes the flat seal and the fixing screw. For other cable plug versions acc. to DIN EN 175301-803 Form A (previously DIN 43650), see separate data-sheet Type 2508. Click on the box "More info." and you will come to our website for this product where you can download the datasheet.

More info.

<sup>1)</sup> The inverter plug includes an electronic which is specially adapted for an electrical control with 3 wires Input 3 wire technology, common "-" polarity, two split "+" polarity. Output suitable for impulse model for Type 6013/6014

## Ordering chart for Manifolds

Accessory parts	Features				Item no.
Single manifold	in aluminium black anodized				005 020
Multiple manifold	in aluminium	Hole spacing A [mm]	Total length B [mm]	Hole spacing C [mm]	
	2 valves	57	65	–	005 023
	3 valves	90	98	–	005 286
	4 valves	123	131	–	005 287
	5 valves	156	164	57	005 035
	6 valves	189	197	57	005 038
	8 valves	255	263	90	005 386
	10 valves	321	329	90	005 764
Covering plate	with plugs and O-ring, for closing off unused valve positions				005 630

Manifolds in Brass or stainless steel on request

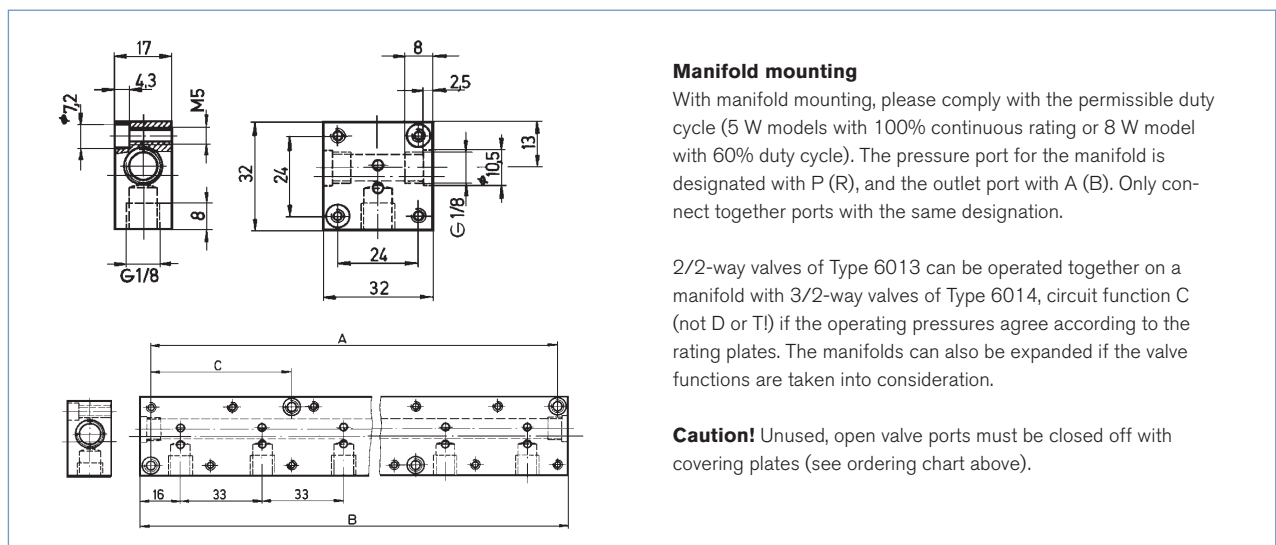

**Dimensions [mm]**

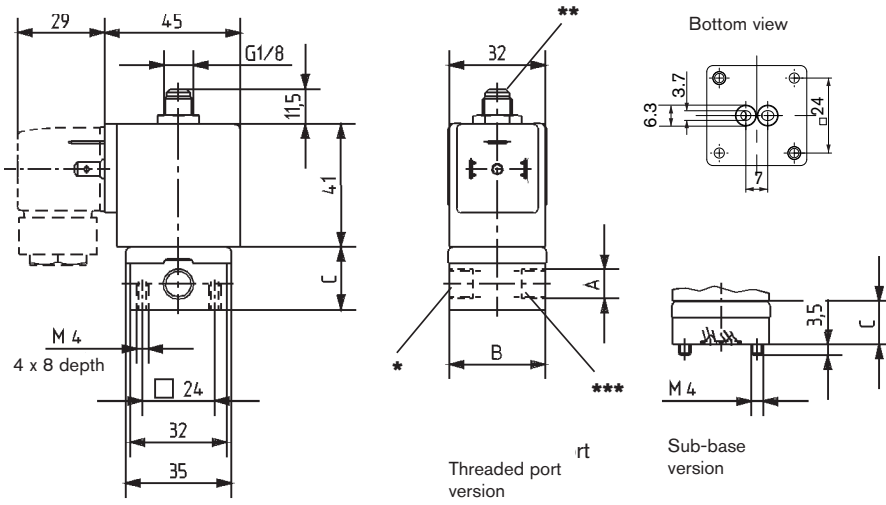

Dimensions [mm]			
version	A	B	C
Threaded port without manual override	G 1/8	32	20.8
	G 1/4	46	26.8
Threaded port with manual override	G 1/8	32	20.8
	G 1/4	46	26.8
Sub-base	-	32	14.3

DTS 1000011035 EN Version: G Status: RL (released | freigegeben | valide) printed: 05.10.2012

To find your nearest Bürkert facility, click on the orange box → [www.burkert.com](http://www.burkert.com)

In case of special application conditions, please consult for advice.

Subject to alterations  
© Christian Bürkert GmbH & Co. KG

1204/5\_EU-en\_00895091